

# Grandstream Networks, Inc.

---

GRP2601(P) | GRP2602(P/W)

GRP2603(P) | GRP2604(P)

Essential IP Phones

## User Guide



**GRP2601/GRP2601P**



**GRP2602/GRP2602P/GRP2602W**



**GRP2603/GRP2603P**



**GRP2604/GRP2604P**



## **COPYRIGHT**

©2021 Grandstream Networks, Inc. <http://www.grandstream.com>

All rights reserved. Information in this document is subject to change without notice. Reproduction or transmittal of the entire or any part, in any form or by any means, electronic or print, for any purpose without the express written permission of Grandstream Networks, Inc. is not permitted.

The latest electronic version of this guide is available for download here:

<http://www.grandstream.com/support>

Grandstream is a registered trademark and Grandstream logo is trademark of Grandstream Networks, Inc. in the United States, Europe, and other countries.

## **CAUTION**

Changes or modifications to this product not expressly approved by Grandstream, or operation of this product in any way other than as detailed by this guide, could void your manufacturer warranty.

## **WARNING**

Please do not use a different power adaptor with devices as it may cause damage to the products and void the manufacturer warranty.



## U.S. FCC Part 68 Regulatory Information

This equipment complies with Part 68 of the FCC rules. Located on the equipment is a label that contains, among other information, the ACTA registration number and ringer equivalence number (REN). If requested, this information must be provided to the telephone company.

The REN is used to determine the quantity of devices which may be connected to the telephone line. Excessive REN's on the telephone line may result in the devices not ringing in response to an incoming call. In most, but not all areas, the sum of the REN's should not exceed five (5.0). To be certain of the number of devices that may be connected to the line, as determined by the total REN's contact the telephone company to determine the maximum REN for the calling area.

This equipment cannot be used on the telephone company-provided coin service. Connection to Party Line Service is subject to State Tariffs.

If this equipment causes harm to the telephone network, the telephone company will notify you in advance that temporary discontinuance of service may be required. If advance notice is not practical, the telephone company will notify the customer as soon as possible. Also, you will be advised of your right to file a complaint with the FCC if you believe it is necessary.

The telephone company may make changes in its facilities, equipment, operations, or procedures that could affect the operation of the equipment. If this happens, the telephone company will provide advance notice in order for you to make the necessary modifications in order to maintain uninterrupted service.

If any trouble experienced with this equipment, please contact (Agent in the US):

**Company Name:** Grandstream Networks, Inc.

**Address:** 126 Brookline Ave, 3rd Floor Boston, MA 02215, USA

**Tel:** 1-617-5669300

**Fax:** 1-617-2491987

If the trouble is causing harm to the telephone network, the telephone company may request you to remove the equipment from the network until the problem is resolved.

This equipment uses the following USOC jacks: RJ45C.

It is recommended that the customer install an AC surge arrester in the AC outlet to which this device is connected. This is to avoid damaging the equipment caused by local lightning strikes and other electrical surges.

Since this device has the HAC function, the earpiece is easy to absorb small, please take care to avoid scratching.



## U.S. FCC Part 15 Regulatory Information

This device complies with part 15 of the FCC Rules. Operation is subject to the following two conditions:

(1) This device may not cause harmful interference, and (2) this device must accept any interference received, including interference that may cause undesired operation.

Any Changes or modifications not expressly approved by the party responsible for compliance could void the user's authority to operate the equipment.

**Note:** This equipment has been tested and found to comply with the limits for a Class B digital device, pursuant to part 15 of the FCC Rules. These limits are designed to provide reasonable protection against harmful interference in a residential installation. This equipment generates, uses, and can radiate radio

Frequency energy and, if not installed and used in accordance with the instructions, may cause harmful interference to radio communications. However, there is no guarantee that interference will not occur in a particular installation. If this equipment does cause harmful interference to radio or television reception, which can be determined by turning the equipment off and on, the user is encouraged to try to correct the interference by one or more of the following measures:

- Reorient or relocate the receiving antenna.
- Increase the separation between the equipment and receiver.
- Connect the equipment into an outlet on a circuit different from that to which the receiver is connected.
- Consult the dealer or an experienced radio/TV technician for help.

This equipment complies with FCC radiation exposure limits set forth for an uncontrolled environment. This equipment should be installed and operated with minimum distance 20cm between the radiator& your body. This transmitter must not be co-located or operating in conjunction with any other antenna or transmitter.



## Caution: Exposure to Radio Frequency Radiation

This equipment complies with EU radiation exposure limits set forth for an uncontrolled environment. This equipment should be installed and operated with minimum distance of 20 cm between the radiator and your body.

## CE Authentication



BE	BG	CZ	DK	DE	EE	IE	EL
ES	FR	HR	IT	CY	LV	LT	LU
HU	MT	NL	AT	PL	PT	RO	SI
SK	FI	SE	NO	IS	LI	CH	TR

In all EU member states, operation of 5150-5350 MHz is restricted to indoor use only.

Hereby, Grandstream Networks, Inc. declares that the radio equipment GRP2602W are in compliance with Directive 2014/53/EU.

The full text of the EU declaration of conformity is available at the following internet address:

<http://www.grandstream.com/support/resources/>

## GNU GPL INFORMATION

GRP260x firmware contains third-party software licensed under the GNU General Public License (GPL). Grandstream uses software under the specific terms of the GPL. Please see the GNU General Public License (GPL) for the exact terms and conditions of the license.

Grandstream GNU GPL related source code can be downloaded from Grandstream web site from:

[http://www.grandstream.com/sites/default/files/Resources/grp260x\\_gnu\\_gpl.zip](http://www.grandstream.com/sites/default/files/Resources/grp260x_gnu_gpl.zip)



## Table of Content

<b>DOCUMENT PURPOSE .....</b>	<b>10</b>
<b>CHANGE LOG .....</b>	<b>11</b>
Firmware Version 1.0.3.18 .....	11
Firmware Version 1.0.1.57 .....	11
Firmware Version 1.0.1.50 .....	11
Firmware Version 1.0.1.41 .....	11
Firmware Version 1.0.1.36 .....	11
Firmware Version 1.0.1.18 .....	11
<b>WELCOME .....</b>	<b>12</b>
<b>PRODUCT OVERVIEW .....</b>	<b>13</b>
Feature Highlights .....	13
Technical Specifications .....	14
<b>GETTING STARTED .....</b>	<b>19</b>
Equipment Packaging .....	19
Connecting and Setting Up the GRP260x .....	20
Using the Phone Stand .....	20
Using the Slots for Wall Mounting .....	20
Connecting the GRP260x .....	21
<b>GETTING TO KNOW GRP260X .....</b>	<b>22</b>
Idle Screen .....	22
Using the Keypad .....	26
Configuration via Keypad .....	28
Characters Input .....	32
<b>TELEPHONY FEATURES .....</b>	<b>34</b>



Make Phone Calls.....	34
<i>Handset, Speaker and Headset Mode</i> .....	34
<i>Multiple SIP Accounts and Lines</i> .....	34
<i>Completing Calls</i> .....	35
<i>Making Calls Using IP Addresses</i> .....	37
Answering Phone Calls.....	37
<i>Receiving Calls</i> .....	37
<i>Do Not Disturb</i> .....	38
<i>Add Contact to Blacklist</i> .....	38
During a Phone Call.....	39
<i>Call Waiting/Call Hold</i> .....	39
<i>Mute</i> .....	39
<i>Call Transfer</i> .....	39
<i>Call Forwarding</i> .....	40
Establish Conferencing calls.....	40
Multi-Purpose Keys (GRP2604 Only).....	41
Virtual Multi-Purpose Keys.....	43
Voicemail.....	45
Call Features.....	45
<b>CONTACTS.....</b>	<b>48</b>
Local Contacts .....	48
Add a single Contact.....	48
Phonebook.....	48
<i>XML Phonebook syntax</i> .....	48
<i>Download/Upload XML Phonebook from Web UI</i> .....	49
<i>3 XML PHONEBOOK URLS</i> .....	50
<b>CALL HISTORY .....</b>	<b>51</b>





Local Call History .....	51
Call History Operations .....	51
<b>DIAGNOSIS .....</b>	<b>52</b>
<b>EHS HEADSET .....</b>	<b>53</b>
<b>RESTORE FACTORY DEFAULT SETTINGS .....</b>	<b>54</b>
Restore factory settings using LCD menu .....	54
Restore to Factory Default via Web GUI .....	54
<b>EXPERIENCING GRP260x .....</b>	<b>55</b>

## Table of Figures

Figure 1: GRP260x Package Content.....	19
Figure 2: phone Stand and Mounting Slots on the GRP260x.....	20
Figure 3: Tab on the Handset Cradle .....	20
Figure 4: GRP2600 Back Side View .....	21
Figure 5: GRP260x Idle Screen .....	22
Figure 6: GRP2601 Keyboard.....	26
Figure 7: GRP2602 Keyboard.....	26
Figure 8: GRP2603 Keyboard.....	27
Figure 9: GRP2604 Keyboard.....	27
Figure 10: Keypad Menu Configuration Flow.....	31
Figure 11 : Key mode configured as line mode.....	34
Figure 12 : Key mode configured as account mode .....	35
Figure 13 : 3-way conference call screen example .....	40
Figure 14 : MPK page .....	41
Figure 15 : MPK Preview .....	42



Figure 16 : MPK Card printing options.....	43
Figure 17 : Install the BLF paper.....	43
Figure 18: 3XML Phonebook .....	50
Figure 19: Factory Functions .....	52

## Table of Tables

Table 1: GRP260x Features in a glance .....	13
Table 2: GRP2601/GRP2601P Technical Specifications .....	14
Table 3: GRP2602/GRP2602P/GRP2602W Technical Specifications.....	15
Table 4: GRP2603/GRP2603P Technical Specifications .....	16
Table 5: GRP2604/GRP2604P Technical Specifications .....	17
Table 6: Equipment Packaging .....	19
Table 7: LCD Display Definitions.....	22
Table 8: GRP260X LCD icons.....	23
Table 9: GRP260x Keypad Buttons .....	27
Table 10: Configuration Menu .....	28
Table 11: Characters input: 123 Mode .....	32
Table 12: Characters input: ABC Mode.....	32
Table 13: Characters input: abc Mode .....	32
Table 14: Ab2 Mode .....	32
Table 15 : Call Features .....	45
Table 16: Call History icons.....	51



## DOCUMENT PURPOSE

This document describes how to configure the GRP260x via phone's LCD menu and web UI menu to fully manipulate phone's features. To learn advanced functions of GRP260x, please visit <http://www.grandstream.com/support> to download the latest "GRP260x Administration Guide".

This guide covers following topics:

- [Product Overview](#)
- [Getting Started](#)
- [Getting to know GRP260x](#)
- [Telephony Features](#)
- [Contacts](#)
- [Call History](#)
- [Connecting to Devices](#)
- [Diagnosis](#)
- [Restore factory default settings](#)
- [Experiencing the GRP260x](#)



## CHANGE LOG

This section documents significant changes from previous versions of user manuals for GRP260x. Only major new features or major document updates are listed here. Minor updates for corrections or editing are not documented here.

### **Firmware Version 1.0.3.18**

- No major changes

### **Firmware Version 1.0.1.57**

- No major changes

### **Firmware Version 1.0.1.50**

- Added ability to finish an attended transfer by on-hooking the phone. [Attended Transfer]
- Added ability to return to idle screen after you press the activated Linekey. [LINE key]

### **Firmware Version 1.0.1.41**

- Added VLAN tag settings on Device LCD menu. [Figure 10: Keypad Menu Configuration Flow]
- Added support to setup a Forward Always softkey on idle screen. [Softkeys in idle screen]

### **Firmware Version 1.0.1.36**

- No major changes.

### **Firmware Version 1.0.1.18**

- This is the initial version for GRP260x.



## WELCOME

Thank you for purchasing Grandstream GRP260X Essential IP Phones.

Part of the GRP series of Carrier-Grade IP Phones, the GRP2601/GRP2602 is an essential 2-line model designed with zero-touch provisioning for mass deployment and easy management. It features a sleek design and a suite of next-generation features including 5-way voice conferencing to maximize productivity and dual band Wi-Fi support (GRP2602W only), EHS support for Plantronics & Jabra & Sennheiser headsets and multi-language support. The GRP series includes carrier-grade security features to provide enterprise-level security, including secure boot, dual firmware images and encrypted data storage. For cloud provisioning and centralized management, the GRP260X is supported by Grandstream's Device Management System (GDMS), which provides a centralized interface to configure, provision, manage and monitor deployments of Grandstream endpoints. Built for the needs of desktop workers and designed for easy deployment by enterprises, service providers and other high-volume markets, the GRP2601/GRP2602 offers an easy-to-use and easy-to-deploy voice endpoint.

Part of the GRP series of Carrier-Grade IP Phones, the GRP2603/GRP2604 is an essential 3-line model designed with zero touch provisioning for mass deployment and easy management. It features a sleek design and a suite of next generation features including: 5-way voice conferencing to maximize productivity, integrated PoE (GRP2603P), full HD audio on both the speaker and handset to allow users to communicate with the utmost clarity, EHS support for Plantronics & Jabra & Sennheiser headsets and multi-language support. The GRP series includes carrier-grade security features to provide enterprise-level security, including secure boot, dual firmware images and encrypted data storage. For cloud provisioning and centralized management, the GRP2603/GRP2604 is supported by Grandstream's Device Management System (GDMS), which provides a centralized interface to configure, provision, manage and monitor deployments of Grandstream endpoints. Built for the needs of desktop workers and designed for easy deployment by enterprises, service providers and other high-volume markets, the GRP2603/GRP2604 offers an easy-to-use and easy-to-deploy voice endpoint.

The GRP260X series deliver superior HD audio quality, rich and leading-edge telephony features, protection for privacy, and broad interoperability with most 3<sup>rd</sup> party SIP devices and leading SIP/NGN/IMS platforms. GRP260X series is the perfect choice for enterprise users looking for a high quality, feature rich multi-line executive IP phone with advanced functionalities and performance.





# PRODUCT OVERVIEW

## Feature Highlights

The following tables contain the major features of the GRP260x:

**Table 1: GRP260x Features in a glance**

	<p><b>GRP2601</b> <b>GRP2601P</b></p>	<ul style="list-style-type: none"> <li>• 4 programmable context-sensitive soft keys.</li> <li>• 10/100M network ports.</li> <li>• Integrated PoE (for GRP2601P only).</li> <li>• 5-way conference.</li> <li>• Electronic Hook Switch (EHS) support for Plantronics &amp; Jabra &amp; Sennheiser.</li> </ul>
	<p><b>GRP2602</b> <b>GRP2602P</b> <b>GRP2602W</b></p>	<ul style="list-style-type: none"> <li>• 2 SIP account keys with dual-color LED</li> <li>• 4 programmable context-sensitive soft keys.</li> <li>• 10/100M network ports.</li> <li>• Integrated PoE (for GRP2602P only).</li> <li>• 5-way conference.</li> <li>• Electronic Hook Switch (EHS) support for Plantronics &amp; Jabra &amp; Sennheiser.</li> <li>• Wi-Fi Support (GRP2602W only)</li> </ul>
	<p><b>GRP2603</b> <b>GRP2603P</b></p>	<ul style="list-style-type: none"> <li>• 3 SIP account keys with dual-color LED.</li> <li>• 4 XML programmable context sensitive soft keys</li> <li>• 132 x 64 backlit graphical LCD display</li> <li>• 10/100/1000 Mbps Ethernet ports.</li> <li>• Integrated PoE (GRP2603P only).</li> <li>• 5-way conference.</li> <li>• Electronic Hook Switch (EHS) support for Plantronics &amp; Jabra &amp; Sennheiser.</li> </ul>



**GRP2604**  
**GRP2604P**

- 3 SIP account keys with dual-color LED.
- 4 XML programmable context sensitive soft keys
- 132 x 64 backlit graphical LCD display
- 10/100/1000 Mbps Ethernet ports.
- Integrated PoE (GRP2604P only).
- 5-way conference.
- Electronic Hook Switch (EHS) support for Plantronics & Jabra & Sennheiser.

## Technical Specifications

The following table resumes all the technical specifications including the protocols / standards supported, voice codecs, telephony features, languages, and upgrade/provisioning settings for the GRP260x series.

**Table 2: GRP2601/GRP2601P Technical Specifications**

<b>Protocols/Standards</b>	SIP RFC3261, TCP/IP/UDP, RTP/RTCP, RTCP-XR, HTTP/HTTPS, ARP, ICMP, DNS(A record, SRV, NAPTR), DHCP, PPPoE, SSH, TFTP, NTP, STUN, SIMPLE, LLDP, LDAP, TR-069, SNMP, 802.1x, TLS, SRTP, IPV6
<b>Network Interfaces</b>	Dual switched auto-sensing 10/100/1000 Mbps Ethernet ports, integrated PoE (GRP2601P only)
<b>Graphic Display</b>	132 x 48 (2.21") LCD display
<b>Feature Keys</b>	4 XML programmable context sensitive soft keys, 5 (navigation, menu) keys. 8 dedicated function keys for: MESSAGE (with LED indicator), TRANSFER, HEADSET, MUTE, SEND/REDIAL, SPEAKERPHONE, VOL+, VOL-
<b>Voice Codec</b>	Support for G7.29A/B, G.711µ/a-law, G.726, G.722(wide-band),G723,iLBC, OPUS, in-band, and out-of-band DTMF(in audio, RFC2833, SIP INFO), VAD, AEC, CNG, PLC, AGC
<b>Auxiliary Ports</b>	RJ9 headset jack (allowing EHS with Plantronics & Jabra & Sennheiser headsets)
<b>Telephony Features</b>	Hold, transfer, forward, 3-way conference, call park, call pickup, downloadable phonebook (XML, LDAP, up to 2000 items), call waiting, call log (up to 800 records), off-hook auto dial, auto answer, click-to-dial, flexible dial plan, hot-desking, personalized music ringtones and music on hold, server redundancy and fail-over
<b>Base Stand</b>	Yes, 1 angle positions available
<b>Wall Mountable</b>	Yes, (*wall mount sold separately)
<b>QoS</b>	Layer 2 QoS (802.1Q, 802.1P) and Layer 3 (ToS, DiffServ, MPLS) QoS
<b>Security</b>	User and administrator level passwords, MD5 and MD5-sess based authentication, 256-bit AES encrypted configuration file, SRTP, TLS, 802.1x media access control, secure boot
<b>Multi-language</b>	English, Chinese, Korean, Japanese, German, Italian, French, Spanish, Portuguese, Russian, Croatian, and more
<b>Upgrade/Provisioning</b>	Firmware upgrade via FTP/TFTP / HTTP / HTTPS, mass provisioning using GDMS/TR-069 or AES encrypted XML configuration file
<b>Power &amp; Green</b>	Universal Power Supply Input 100-240VAC 50-60Hz; Output +5VDC, 600mA;



<b>Energy Efficiency</b>	PoE: IEEE802.3af Class 1, 3.84W; IEEE802.3az (EEE) (GRP2601P Only)
<b>Physical</b>	Dimension: 208mm (L) x 180mm (W) x 63.4mm (H) (with handset) Unit weight:650g; Package weight:810g (860g for GRP2601)
<b>Temperature and Humidity</b>	Operation: 0°C to 40°C Storage: -10°C to 60°C Humidity: 10% to 90% Non-condensing
<b>Package Content</b>	GRP2601/2601P phone, handset with cord, base stand, universal power supply (GRP2601 only), network cable, Quick Installation Guide
<b>Compliance</b>	FCC: Part 15 Class B; FCC Part 68 HAC; CE: EN 55032; EN 55035; EN 61000-3-2; EN 61000-3-3; EN 62368-1; RCM: AS/NZS CISPR32; AS/NZS 62368.1; AS/CA S004; IC: ICES-003; CS-03;

**Table 3: GRP2602/GRP2602P/GRP2602W Technical Specifications**

<b>Protocols/Standards</b>	SIP RFC3261, TCP/IP/UDP, RTP/RTCP, RTCP-XR, HTTP/HTTPS, ARP, ICMP, DNS(A record, SRV, NAPTR), DHCP, PPPoE, SSH, TFTP, NTP, STUN, SIMPLE, LLDP, LDAP, TR-069, SNMP, 802.1x, TLS, SRTP, IPV6
<b>Network Interfaces</b>	Dual switched auto-sensing 10/100/1000 Mbps Ethernet ports, integrated PoE (GRP2602P only)
<b>Graphic Display</b>	132 x 48 (2.21") backlit graphical LCD display
<b>Wi-Fi</b>	Yes , Dual band support (GRP2602W only)
<b>Feature Keys</b>	2 SIP account keys with dual-color LED, 4 XML programmable context sensitive soft keys, 5 (navigation, menu) keys. 8 dedicated function keys for: MESSAGE (with LED indicator), TRANSFER, HEADSET, MUTE, SEND/REDIAL, SPEAKERPHONE, VOL+, VOL-
<b>Voice Codec</b>	Support for G.729A/B, G.711µ/a-law, G.726, G.722(wide-band),G723,iLBC, OPUS, in-band, and out-of-band DTMF(in audio, RFC2833, SIP INFO), VAD, AEC, CNG, PLC, AGC
<b>Auxiliary Ports</b>	RJ9 headset jack (allowing EHS with Plantronics & Jabra & Sennheiser headsets)
<b>Telephony Features</b>	Hold, transfer, forward, 3-way conference, call park, call pickup, shared-call-appearance(SCA)/bridged-line-appearance(BLA), downloadable phonebook (XML, LDAP, up to 2000 items), call waiting, call log (up to 800 records), off-hook auto dial, auto answer, click-to-dial, flexible dial plan, hot-desking, personalized music ringtones and music on hold, server redundancy and fail-over
<b>HD audio</b>	Yes, HD handset and speakerphone with support for wideband audio
<b>Base Stand</b>	Yes, 1 angle positions available
<b>Wall Mountable</b>	Yes, (*wall mount sold separately)
<b>QoS</b>	Layer 2 QoS (802.1Q, 802.1p) and Layer 3 (ToS, DiffServ, MPLS) QoS
<b>Security</b>	User and administrator level passwords, MD5 and MD5-sess based authentication, 256-bit AES encrypted configuration file, SRTP, TLS, 802.1x media access control, secure boot
<b>Multi-language</b>	English, Chinese, Korean, Japanese, German, Italian, French, Spanish, Portuguese, Russian, Croatian and more
<b>Upgrade/Provisioning</b>	Firmware upgrade via FTP/TFTP / HTTP / HTTPS, mass provisioning using GDMS/TR-069 or AES encrypted XML configuration file
<b>Power &amp; Green Energy Efficiency</b>	Universal Power Supply Input 100-240VAC 50-60Hz; Output +5VDC, 600mA; PoE: IEEE802.3af Class 1, 3.84W; IEEE802.3az (EEE) (GRP2602P Only)
<b>Physical</b>	Dimension: 208mm (L) x 180mm (W) x 63.4mm (H) (with handset) Unit weight: 670g; Package weight:830g (880g for GRP2602)





<b>Temperature and Humidity</b>	Operation: 0°C to 40°C Storage: -10°C to 60°C Humidity: 10% to 90% Non-condensing
<b>Package Content</b>	GRP2602 phone, handset with cord, base stand, universal power supply (GRP2602/GRP2602W only), network cable, Quick Installation Guide
<b>Compliance</b>	FCC: Part 15 Class B; FCC Part 68 HAC; CE: EN 55032; EN 55035; EN 61000-3-2; EN 61000-3-3; EN 62368-1; RCM: AS/NZS CISPR32; AS/NZS 62368.1; AS/CA S004; IC: ICES-003; CS-03;

**Table 4: GRP2603/GRP2603P Technical Specifications**

<b>Protocols/Standards</b>	SIP RFC3261, TCP/IP/UDP, RTP/RTCP, RTCP-XR, HTTP/HTTPS, ARP, ICMP, DNS(A record, SRV, NAPTR), DHCP, PPPoE, SSH, TFTP, NTP, STUN, SIMPLE, LLDP, LDAP, TR-069, SNMP, 802.1x, TLS, SRTP, IPV6
<b>Network Interfaces</b>	Dual switched auto-sensing 10/100/1000 Mbps Ethernet ports, integrated PoE (GRP2603P only)
<b>Graphic Display</b>	132 x 64 backlit graphical LCD display
<b>Feature Keys</b>	3 SIP account keys with dual-color LED, 4 XML programmable context sensitive soft keys, 5 (navigation, menu) keys. 9 dedicated function keys for: MESSAGE(with LED indicator), TRANSFER, HOLD, HEADSET, MUTE, SEND/REDIAL, SPEAKERPHONE, VOL+, VOL-
<b>Voice Codec</b>	Support for G7.29A/B, G.711 $\mu$ /a-law, G.726, G.722(wide-band),G723,iLBC, OPUS, in-band, and out-of-band DTMF(in audio, RFC2833, SIP INFO), VAD, AEC, CNG, PLC, AGC
<b>Auxiliary Ports</b>	RJ9 headset jack (allowing EHS with Plantronics & Jabra & Sennheiser headsets)
<b>Telephony Features</b>	Hold, transfer, forward, 4-way conference, call park, call pickup, shared-call-appearance(SCA)/bridged-line-appearance(BLA), downloadable phonebook (XML, LDAP, up to 2000 items), call waiting, call log (up to 800 records), off-hook auto dial, auto answer, click-to-dial, flexible dial plan, hot-desking, personalized music ringtones and music on hold, server redundancy and fail-over
<b>HD audio</b>	Yes, HD handset and speakerphone with support for wideband audio
<b>Base Stand</b>	Yes, 2 angle positions available
<b>Wall Mountable</b>	Yes, (*wall mount sold separately)
<b>QoS</b>	Layer 2 QoS (802.1Q, 802.1p) and Layer 3 (ToS, DiffServ, MPLS) QoS
<b>Security</b>	User and administrator level passwords, MD5 and MD5-sess based authentication, 256-bit AES encrypted configuration file, SRTP, TLS, 802.1x media access control, secure boot
<b>Multi-language</b>	English, Chinese, Korean, Japanese, German, Italian, French, Spanish, Portuguese, Russian, Croatian, and more
<b>Upgrade/Provisioning</b>	Firmware upgrade via FTP/TFTP / HTTP / HTTPS, mass provisioning using GDMS/TR-069 or AES encrypted XML configuration file
<b>Power &amp; Green Energy Efficiency</b>	Universal Power Supply Input 100-240VAC 50-60Hz; Output +5VDC, 600mA;PoE: IEEE802.3af Class 1, 3.84W; IEEE802.3az (EEE) (GRP2603P Only)
<b>Physical</b>	Dimension: 214mm (L) x 206mm (W) x 68mm (H) (with handset) Unit weight: 780g; Package weight: 1090g for GRP2603P &1140g for GRP2603
<b>Temperature and Humidity</b>	Operation: 0°C to 40°C Storage: -10°C to 60°C Humidity: 10% to 90% Non-condensing
<b>Package Content</b>	GRP2603 phone, handset with cord, base stand, universal power supply (GRP2603 only), network cable, Quick Installation Guide



<b>Compliance</b>	FCC: Part 15 Class B; FCC Part 68 HAC; CE: EN 55032; EN 55035; EN 61000-3-2; EN 61000-3-3; EN 62368-1; RCM: AS/NZS CISPR32; AS/NZS 62368.1; AS/CA S004; IC: ICES-003; CS-03;
-------------------	---

**Table 5: GRP2604/GRP2604P Technical Specifications**

<b>Protocols/Standards</b>	SIP RFC3261, TCP/IP/UDP, RTP/RTCP, RTCP-XR, HTTP/HTTPS, ARP, ICMP, DNS(A record, SRV, NAPTR), DHCP, PPPoE, SSH, TFTP, NTP, STUN, SIMPLE, LLDP, LDAP, TR-069, SNMP, 802.1x, TLS, SRTP, IPV6
<b>Network Interfaces</b>	Dual switched auto-sensing 10/100/1000 Mbps Ethernet ports, integrated PoE (GRP2603P only)
<b>Graphic Display</b>	132 x 64 backlit graphical LCD display
<b>Feature Keys</b>	3 SIP account keys with dual-color LED, 4 XML programmable context sensitive soft keys, 5 (navigation, menu) keys. 9 dedicated function keys for: MESSAGE(with LED indicator), TRANSFER, HOLD, HEADSET, MUTE, SEND/REDIAL, SPEAKERPHONE, VOL+, VOL-
<b>Voice Codec</b>	Support for G.729A/B, G.711 $\mu$ /a-law, G.726, G.722(wide-band),G723,iLBC, OPUS, in-band, and out-of-band DTMF(in audio, RFC2833, SIP INFO), VAD, AEC, CNG, PLC, AGC
<b>Auxiliary Ports</b>	RJ9 headset jack (allowing EHS with Plantronics & Jabra & Sennheiser headsets)
<b>Telephony Features</b>	Hold, transfer, forward, 4-way conference, call park, call pickup, shared-call-appearance(SCA)/bridged-line-appearance(BLA), downloadable phonebook (XML, LDAP, up to 2000 items), call waiting, call log (up to 800 records), off-hook auto dial, auto answer, click-to-dial, flexible dial plan, hot-desking, personalized music ringtones and music on hold, server redundancy and fail-over
<b>HD audio</b>	Yes, HD handset and speakerphone with support for wideband audio
<b>Base Stand</b>	Yes, 2 angle positions available
<b>Wall Mountable</b>	Yes, (*wall mount sold separately)
<b>QoS</b>	Layer 2 QoS (802.1Q, 802.1p) and Layer 3 (ToS, DiffServ, MPLS) QoS
<b>Security</b>	User and administrator level passwords, MD5 and MD5-sess based authentication, 256-bit AES encrypted configuration file, SRTP, TLS, 802.1x media access control, secure boot
<b>Multi-language</b>	English, German, Italian, French, Spanish, Portuguese, Russian, Croatian, Chinese, Korean, Japanese, and more
<b>Upgrade/Provisioning</b>	Firmware upgrade via FTP/TFTP / HTTP / HTTPS, mass provisioning using GDMS/TR-069 or AES encrypted XML configuration file
<b>Power &amp; Green Energy Efficiency</b>	Universal Power Supply Input 100-240VAC 50-60Hz; Output +5VDC, 600mA;PoE: IEEE802.3af Class 2, 3.84W-6.49W; IEEE802.3az (EEE) (GRP2604P Only)
<b>Physical</b>	Dimension: 208mm (L) x 180mm (W) x 63.4mm (H) (with handset) Unit weight: 670g; Package weight:830g (880g for GRP2602)
<b>Temperature and Humidity</b>	Operation: 0°C to 40°C Storage: -10°C to 60°C Humidity: 10% to 90% Non-condensing
<b>Package Content</b>	GRP2604 phone, handset with cord, base stand, universal power supply (GRP2604 only), network cable, Quick Installation Guide
<b>Compliance</b>	FCC: Part 15 Class B; FCC Part 68 HAC; CE: EN 55032; EN 55035; EN 61000-3-2; EN 61000-3-3; EN 62368-1; RCM: AS/NZS CISPR32; AS/NZS 62368.1; AS/CA S004; IC: ICES-003; CS-03;



## GETTING STARTED

This chapter provides basic installation instructions including the list of the packaging contents and information for obtaining the best performance with the GRP260x phone.

### Equipment Packaging

**Table 6: Equipment Packaging**

GRP260x
<ul style="list-style-type: none"> <li>• 1 x GRP260x Main Case.</li> <li>• 1 x Handset.</li> <li>• 1 x Phone Stand.</li> <li>• 1 x Ethernet Cable.</li> <li>• 1 x Power Adapter (Except for GRP260xP).</li> <li>• 1 x Phone cord.</li> <li>• 1 x Quick Installation Guide</li> </ul>

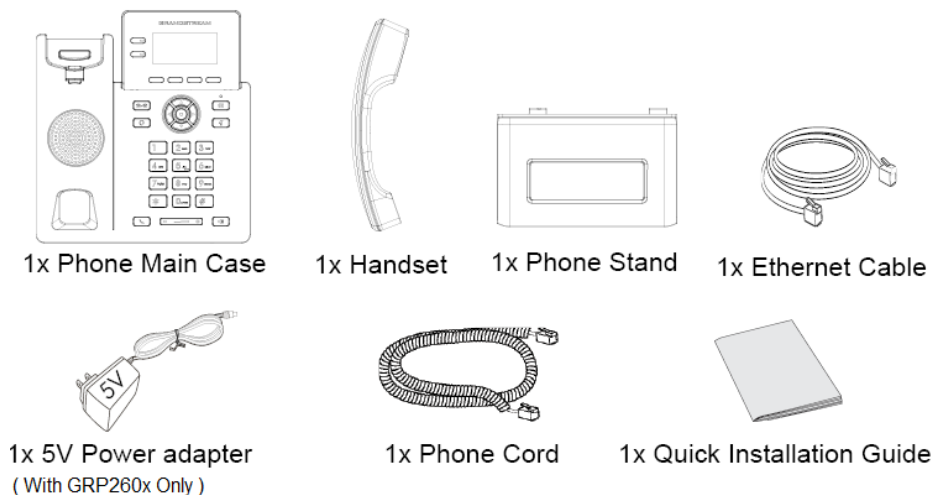

**Figure 1: GRP260x Package Content**

**Note:**

Check the package before installation. If you find anything missing, contact your system administrator.

## Connecting and Setting Up the GRP260x

The GRP260x phones can be installed on the desktop using the phone stand or attached on the wall using the slots for wall mounting.

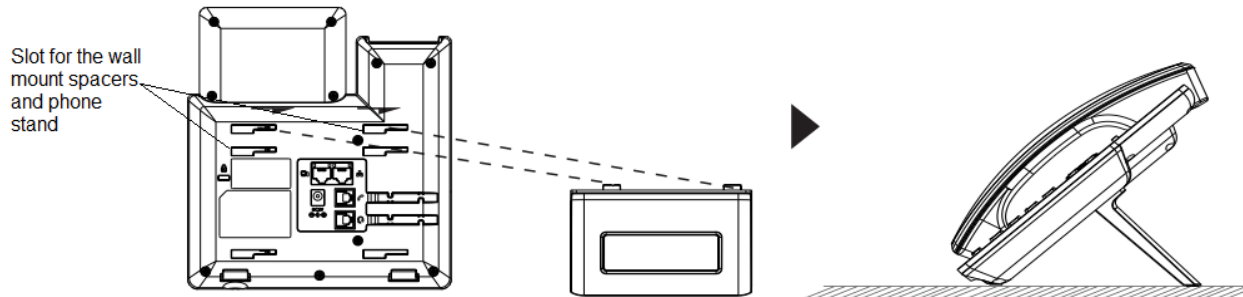

Figure 2: phone Stand and Mounting Slots on the GRP260x

### Using the Phone Stand

To install the phone on the table with the phone stand, attach the phone stand to the bottom of the phone through the phone stand slot. (Upper half, bottom part).

### Using the Slots for Wall Mounting

1. Attach the wall mount spacers to the slot for wall mount spacers on the back of the phone.
2. Attach the phone to the wall via the wall mount hole.
3. Pull out the tab from the handset cradle (See figure below).
4. Rotate the tab and plug it back into the slot with the extension up to hold the handset while the phone is mounted on the wall (See figure below).

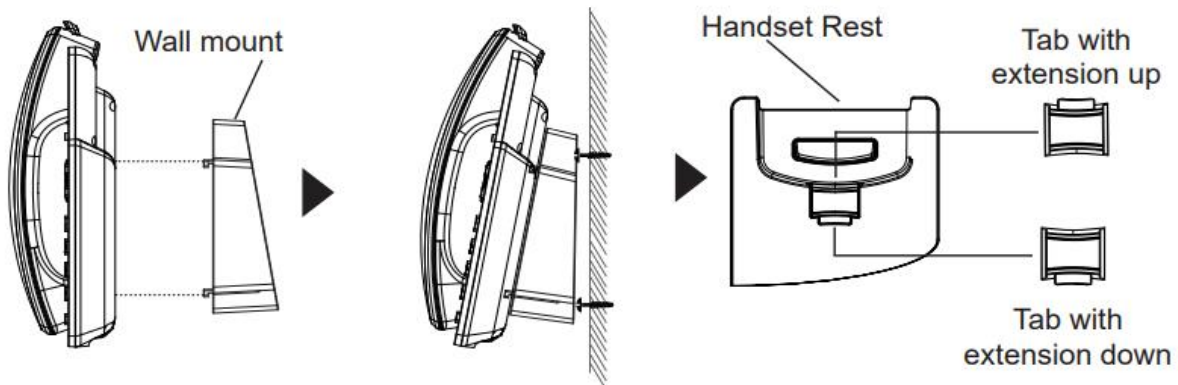

Figure 3: Tab on the Handset Cradle

## Connecting the GRP260x

To setup the GRP2600, follow the steps below:

1. Connect the handset and main phone case with the phone cord.
2. Connect the LAN port of the phone to the RJ-45 socket of a hub/switch or a router (LAN side of the router) using the Ethernet cable.
3. Connect the PSU output plug to the power jack on the phone; plug the power adapter into an electrical outlet. If PoE switch is used in step 2 (GRP2601P/GRP2602P/GRP2603P/GRP2604P only), this step could be skipped.
4. The LCD will display Grandstream logo. Before continuing, please wait for the date/time display to show up.
5. Using the phone embedded web server or keypad configuration menu, you can further configure the phone using either a static IP or DHCP.

### Connecting to Wi-Fi Network (GRP2602W only)

- On LCD menu, navigate to “Settings → Wi-Fi settings” and enable Wi-Fi.
- Select “Wi-Fi Network” and GRP2602W will automatically start scanning within the range.
- A list of Wi-Fi networks will be displayed. Select the desired network, and if required, enter the correct password to connect.
- Users can add and connect to a hidden network by accessing “Wi-Fi” Network” and then press on Add softkey **+**. Then enter the Network’s information.

### Notes:

- When the GPR2602W is not connected to any network (including Ethernet and Wi-Fi), a prompt interface will pop up to notify users about it. Users can quickly enter “Wi-Fi Network” page by pressing on the Wi-Fi softkey.
- For easy deployment, The GRP2602W is out of the box is preconfigured to connect to a default SSID named **wp\_master** with a password (WPA/WPA2 PSK) equal to **wp!987@dmin**, users can adapt these settings from the web UI as well to make it easier for deployment on customer site.

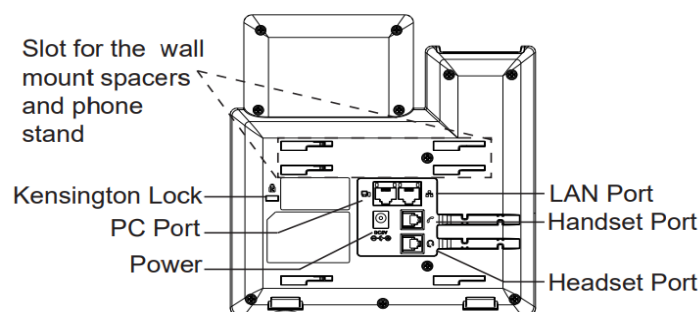

Figure 4: GRP2600 Back Side View

# GETTING TO KNOW GRP260X

## Idle Screen

GRP260x screen displays differently depending on whether the phone is idle or in use (active). The following figures show the idle screen of GRP260x.

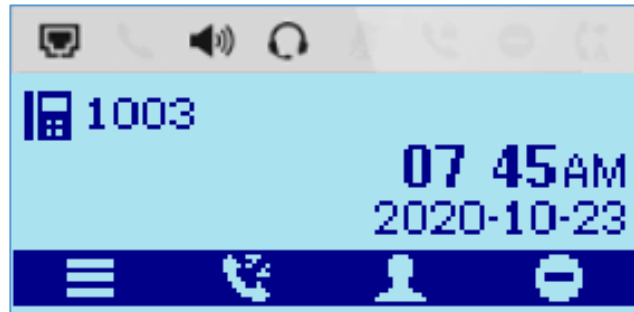

Figure 5: GRP260x Idle Screen

The following table describes the items displayed on the GRP260x idle screen:

Table 7: LCD Display Definitions

<b>Date and Time</b>	Displays the current date and time. It can be synchronized with Internet time servers.
<b>Network icon</b>	Shows the status of network. It will indicate whether the network is down or starting.
<b>Status icon</b>	Shows the status of the phone for registration status, call features etc., using icons as shown in the next table.
<b>Line status indicator</b>	Displays the name of the account that is in use.
<b>Softkeys in idle screen</b>	<p>The softkeys are context sensitive and will change depending on the status of the phone. Default functions assigned to softkeys are:</p> <ul style="list-style-type: none"> <li>• <b>Menu</b> Brings up the phone's main menu.</li> <li>• <b>History</b> Shows up the phone's call history.</li> <li>• <b>Contacts</b> Access local phonebook and groups.</li> <li>• <b>DND</b> Enable/Disable DND.</li> </ul> <p><b>Note:</b> The Idle Screen Softkey can be customized under web UI &gt; Programmable Keys &gt; Idle Screen Softkeys &gt; Custom Softkey Layout</p>
<b>Softkeys in call screen</b>	<p>The softkeys are context sensitive and will change depending on the call status of the phone. Here are the main softkeys in call screen.</p> <ul style="list-style-type: none"> <li>• <b>Dial</b> Dials the call out after off hook and entering the number.</li> </ul>

- **Answer Call softkey**  
Answers the incoming call when the phone is ringing.
- **Reject Call softkey**  
Rejects the incoming call when the phone is ringing.
- **End Call softkey**  
Ends the active call.
- **Transfer softkey**  
Transfer softkey will show up after pressing TRAN button and entering transfer target number. Press Transfer softkey to do blind transfer.
- **Switch softkey**  
In attended transfer mode, after establishing the second call, press on Switch softkey to switch between the two calls.

Table 8: GRP260X LCD icons

	Registered Account		Warning
	Registered SCA Account		Info
	Unregistered account / account is not available		Detail
	Calling / Dialing / Accept		The first page
	Incoming Call		The second page
	Dial		Line Switch Indicator
	Call failed / Missed Call		Left arrow
	Held		Right arrow
	Talking		Switch_Off
	Edit before dialing		Switch_On
	Dial DTMF		Mixed Input Method (Default)
	New Call		Capital Letter Input Method
	Redial		Lowercase Input Method
	Call Return		Digital Input Method
	Hang up		Settings / Configuration
	Call Waiting		Call Center Account available
	Speed Dial/Speed Dial via Active Account		Call Center Account Unavailable
	Transfer		Multicast Listen





	Call Forward All		Close Call Forward All
	Call History		BS Contacts
	Blocked Calls		BS Call History
	Contact		Call Park
	New Contact / Invite		Call Pick
	Delete Contact / Remove		Call Park Status
	Group		Ringtone Off
	New Group		Logout
	Group Members		Recording Pause
	Blacklist		Conference Hold
	Remove from Blacklist		Conference Talking
	Clear all Blacklist		Hoteling
	Conference		Remote Search
	Incoming Cloud Conference		Sort
	Outgoing Cloud Conference		Noise Shield
	Missed Cloud Conference		Noise Shield Off
	GDS Door		More
	GDS Door Open		Lock Screen
	Hold		Unlock Screen
	UnHold		Voicemail Unread
	Recording On		Play
	Recording Off		Stop
	Power Off		Play Status
	DND		Stop Status
	Menu		Mark as Unread
	Back		Mark as Read



	Download		Mark All as Read
	Download To...		Bridge
	Downloading		Share
	Upgrade System		Call Pull
	Edit		Password / Lock Status
	Delete		Add
	Delete All		Wi-Fi
	Refresh		Wi-Fi 5G Excellent
	More (page select)		Wi-Fi 5G Good
	LDAP Search		Wi-Fi 5G Fair
	Search		Wi-Fi 5G Poor
	OK / Save		Wi-Fi 2.4G Excellent
	Cancel		Wi-Fi 2.4G Good
	Backspace		Wi-Fi 2.4G Fair
	Switch / Convert		Wi-Fi 2.4G Poor
	Text Message		Wi-Fi Excellent
	New Text Message		Wi-Fi Good
	Speaker		Wi-Fi Fair
	Login		Wi-Fi Poor
	Ringtone		Wi-Fi Disconnect
	Ringtone Off		Connect
	Headset		Disconnect / Forget
	Voicemail		UnRegistered SCA Account
	Intercom		Mark All as Unread
	Single Box		Noise Filtering



<input type="checkbox"/>	Checkbox not selected		Noise Filtering Off
<input checked="" type="checkbox"/>	Checkbox selected		Noise Filtering Status
	Speaker Off		

## Using the Keypad

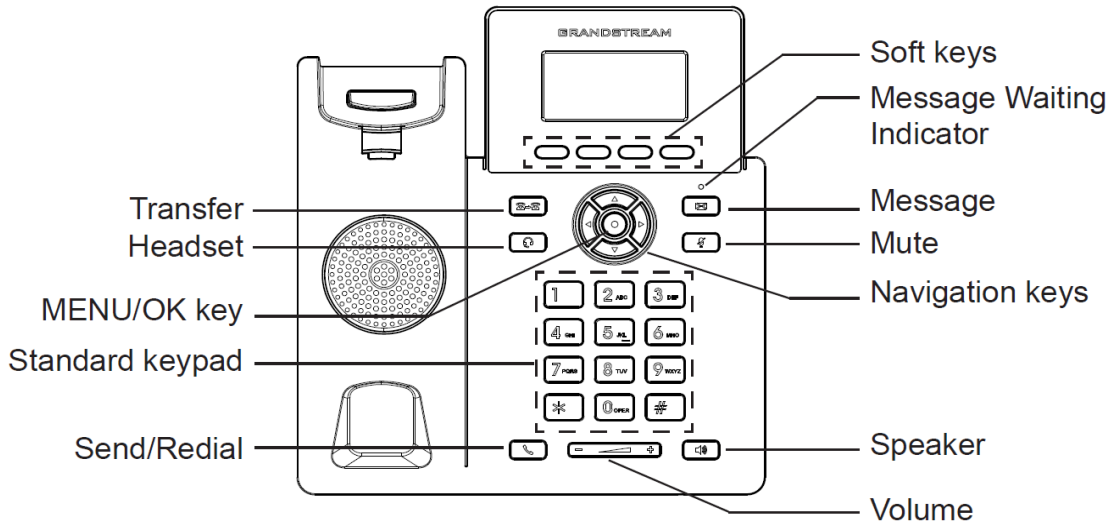

Figure 6: GRP2601 Keyboard

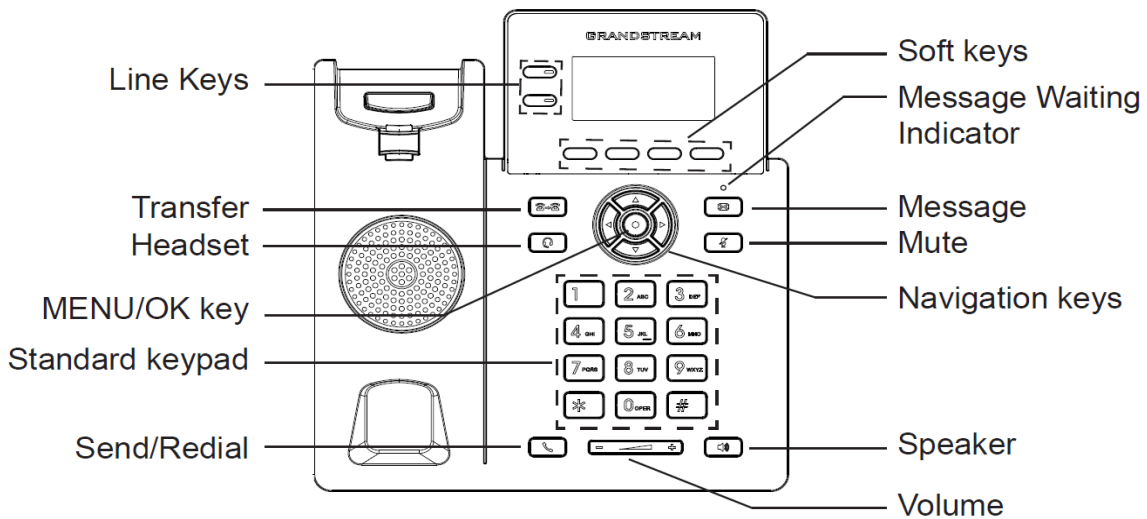

Figure 7: GRP2602 Keyboard

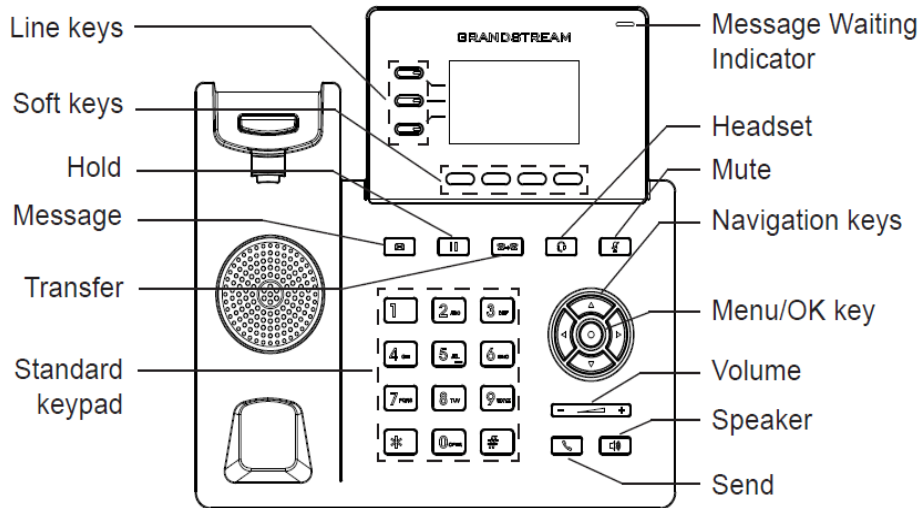

Figure 8: GRP2603 Keyboard

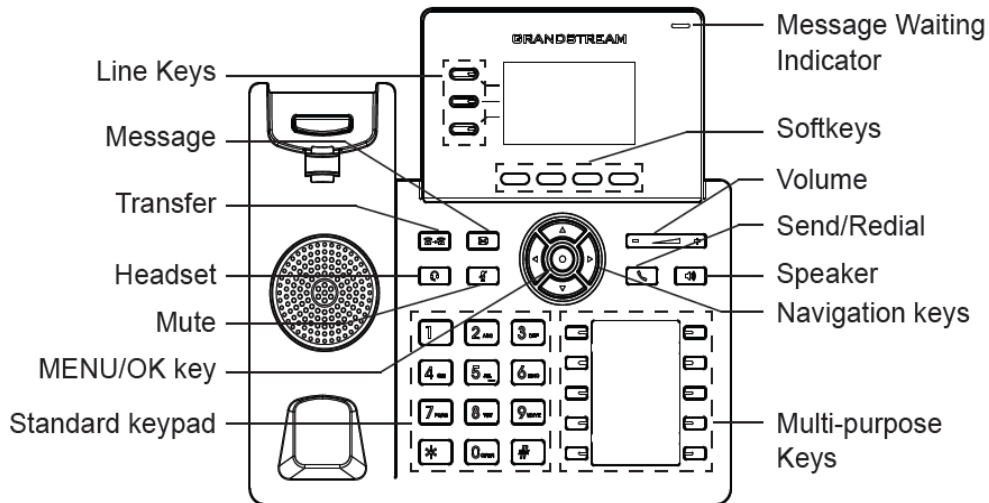



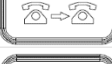

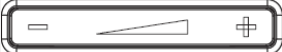
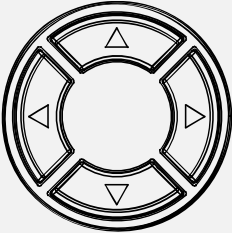



Figure 9: GRP2604 Keyboard

Table 9: GRP260x Keypad Buttons



	<b>Hold.</b> Press to put call on hold or resume the call.
	<b>Mute.</b> <ul style="list-style-type: none"> <li>• During a call, Press Mute button to mute or unmute the call.</li> <li>• When the phone is on idle, Press to Enable/Disable DND</li> </ul>
	<b>Headset.</b> Press to switch between headset and handset mode in an active call.
	<b>Message.</b> Press to view voicemail messages.
	<b>Transfer.</b> Press to transfer an active call to another number.
	<b>Speaker.</b> Press to switch between speaker and handset mode in an active call.



	<b>Send/Redial</b>
	<b>Volume.</b> Adjust volume.
	<b>Navigation keys.</b> <ul style="list-style-type: none"> <li>• In idle screen, press up key to display the IP.</li> <li>• When entered the menu, Press the UP/DOWN keys to scroll through menu options.</li> <li>• Use RIGHT/LEFT keys to switch between Tabs or to toggle between enabling and disabling some options. for example: switch between “All” and “Missed” Calls Tabs in call history</li> </ul>
	<b>MENU button.</b> <ul style="list-style-type: none"> <li>• In idle screen, press to enter the main menu.</li> <li>• Confirm the current selection or the inputted info.</li> </ul>

## Configuration via Keypad

To configure the LCD menu using the phone’s keypad, follow the instructions below:

- **Enter MENU options.** When the phone is in idle, press the round MENU button or Menu Softkey  to enter the configuration menu.
- **Navigate in the menu options.** Press the arrow keys UP/DOWN keys to navigate in the menu options.
- **Enter/Confirm selection.** Press the round MENU to enter the selected option.
- **Exit.** Press Return Softkey  to exit to the previous menu.
- **Return to Home page.**

The MENU options are listed in the following table.

Table 10: Configuration Menu

<b>Status</b>	Displays account status, network status, software version number and Hardware <ul style="list-style-type: none"> <li>• <b>Network status.</b> Press to enter the sub menu for IP setting information (DHCP/Static IP/PPPoE), IPv4 address, IPv6 address, MAC address, Subnet Mask, Gateway, DNS and NTP servers.</li> <li>• <b>Account status.</b> Shows Account registration status.</li> <li>• <b>System Status</b> Press to enter the sub menu for Hardware Information, Software version and IP</li> </ul>
---------------	--

## Geographic Information.

Settings sub menu contains the following options:

- **Account Settings**

Enable/Disable SIP account, Configures Account Name, SIP server's address, SIP User ID, SIP Auth ID, SIP Password, Outbound Proxy, and Voice Mail Access Number.

- **Call Settings**

Enable/Disable **DND**, Enable/Disable **Auto Answer** for SIP account, Enable/Disable **Call Forward (Forward All/Busy/No Answer)**.

- **Basic Settings**

- **Sounds**

Configures account ringtone and adjusts volume settings by pressing left/right arrow key.

- **Date Time**

Adjusts Time and Date displaying format.

- **Time Zone**

Choose your Time Zone from the list by scrolling with UP/DOWN keys.

- **Language**

Selects the language to be displayed on the phone's LCD. Users could select Automatic for local language based on IP location if available. By default, it is Auto.

- **Keypad Lock**

Enables/Disables Keypad lock. Users can choose the Keypad Lock type (All Keys/Functional keys) and set up the lock password. If users enabled Keypad lock without configuring a password; They can unlock the phone by pressing on the unlock softkey.

- **Headset Type**

Choose the headset type of the headset connect to the phone. Users could choose Normal, Plantronics EHS, Jabra EHS, Sennheiser EHS.

- **Advanced settings**

- **Upgrade**

Check for upgrade by contacting the firmware upgrade server.

- **Syslog**

Configures Syslog level, Transport protocol and Syslog Server's address.

- **Security**

Enables/disables Web and SSH access.

- **Alternative Firmware**

Press  softkey to switch between the dual firmware versions loaded to the phone. The phone will reboot with the chosen version.

- **Factory Reset:**

Perform Factory reset to the phone. All device configuration and user data will be lost after factory reset.

- **Ethernet Settings**

- **Internet Protocol**

Selects Prefer IPv4 / Prefer IPv6 / IPv4 only or IPv6 only. The default setting

	<p>is “IPv4 only”.</p> <ul style="list-style-type: none"> <li>○ <b>IPv4 Setting</b> Selects IP mode (DHCP/Static IP/PPPoE); Configures PPPoE account ID and password; Configures static IP address, Netmask, Gateway, Preferred DNS server.</li> <li>○ <b>IPv6 Setting</b> Selects IP mode (DHCP/Static IP); Configures static IP address, IPv6 Prefix (64 bits), IPv6 Preferred DNS server.</li> <li>○ <b>VLAN Setting</b> Enables CDP/LLDP, Configures LLDP TX interval, Enables Manual VLAN Configuration, Configures Layer 2 QoS 802.1q (VLAN ID/Priority).</li> <li>● <b>Wi-Fi Settings (GRP2602W only)</b> <ul style="list-style-type: none"> <li>○ <b>Wi-Fi</b> Enables/disables Wi-Fi;</li> <li>○ <b>Wi-Fi Band</b> Choose Wi-Fi band (2G , 5G or 2G&amp;5G).</li> <li>○ <b>Wi-Fi Network</b> Scans and displays available Wi-Fi networks.</li> </ul> </li> </ul>
<b>Messages</b>	<ul style="list-style-type: none"> <li>● <b>Instant Messages</b> Displays received instant messages</li> <li>● <b>Voicemail</b> Displays voicemail message information in the following format: Normal/Urgent</li> </ul>
<b>Call History</b>	<p>Displays Local Call Logs: “All” Calls / “Missed” Calls/ “Dialed” Calls/ “Answered” Calls.</p>
<b>Contacts</b>	<p><b>Contacts</b> sub menu includes the following options:</p> <ul style="list-style-type: none"> <li>● <b>Local Phonebook</b></li> <li>● <b>Local Group</b></li> <li>● <b>LDAP</b></li> </ul> <p>User could configure phonebooks/groups options here, download phonebook XML to the phone and search and dial from the local phonebook and search and dial from LDAP phonebook.</p>
<b>Factory Functions</b>	<p>Factory Functions sub menu includes the following options:</p> <ul style="list-style-type: none"> <li>● <b>Audio Loopback</b> Speak to the phone using speaker/handset/headset. If you can hear your voice, your audio is working fine. Press Return Softkey to exit audio loopback mode.</li> <li>● <b>Keypad/Led diagnosis</b> All LEDs will light up Press all the available keys on the phone. The LCD will display the name for the keys to be pressed to finish the keyboard diagnostic mode. Press Hook button to exit.</li> <li>● <b>Certification Verification</b> Verify the certificate loaded on the phone.</li> </ul>
<b>Reboot</b>	<p>Reboots the phone.</p>



The following picture shows the keypad MENU configuration flow:

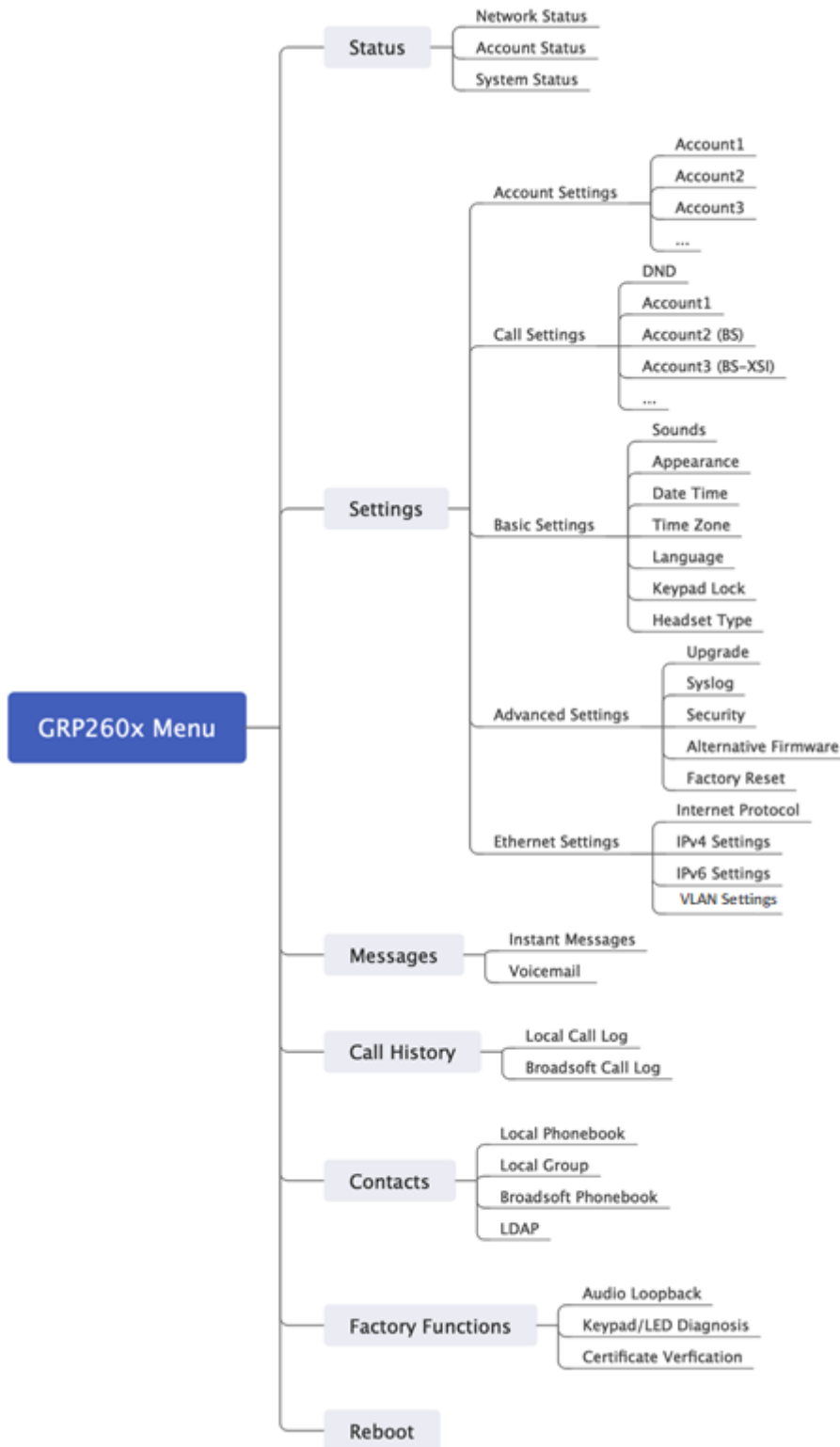

Figure 10: Keypad Menu Configuration Flow





## Characters Input

The GRP260x keypad can be used by tapping on an input field. GRP260x keypad has 4 modes “123”, “ABC”, “abc” and “Ab2”. Default mode is “Ab2”. Note: If the input field is accepting only digits, only “123” mode will be available.

- **“123” Mode:** This mode allows to enter digits and:.

Following table describes allowed characters for each key.

Table 11: Characters input: 123 Mode

Key	Description	Key	Description	Key	Description
1	1	2	2	3	3
4	4	5	5	6	6
7	7	8	8	9	9
*	.	0	0	#	:

- **“ABC” Mode:** This mode allows to enter capital letters, digits, and symbolic characters.

Following table describes allowed characters for each key.

Table 12: Characters input: ABC Mode

Key	Description	Key	Description	Key	Description
1	1 . : @ + , ' " - ? ! ( ) / _ ; % = < > \$ [ ] { } \ ~ ^   ` &	2	A B C 2	3	D E F 3
4	G H I 4	5	J K L 5	6	M N O 6
7	P Q R S 7	8	T U V 8	9	W X Y Z 9
*	*	0	0	#	#

- **“abc” Mode:** This mode allows to enter small letters, digits, and symbolic characters.

Following table describes allowed characters for each key.

Table 13: Characters input: abc Mode

Key	Description	Key	Description	Key	Description
1	1 . : @ + , ' " - ? ! ( ) / _ ; % = < > \$ [ ] { } \ ~ ^   ` &	2	a b c 2	3	e d f 3
4	g h i 4	5	j k l 5	6	m n o 6
7	p q r s 7	8	t u v 8	9	w x y z 9
*	*	0	0	#	#

- **“Ab2” Mode:** This mode allows to enter capital letters, small letters, digits, and symbolic characters.

Following table describes allowed characters for each key.

Table 14: Ab2 Mode

Key	Description	Key	Description	Key	Description
1	1 . : @ + , ' " - ? ! ( ) / _ ; %	2	A B C a b c 2	3	D E F e d f 3





	= < > \$ [ ] { } \ ~ ^   ` &				
<b>4</b>	G H I g h i 4	<b>5</b>	J K L j k l 5	<b>6</b>	M N O m n o 6
<b>7</b>	P Q R S p q r s 7	<b>8</b>	T U V t u v 8	<b>9</b>	W X Y Z w x y z 9
<b>*</b>	*	<b>0</b>	0	<b>#</b>	#

# TELEPHONY FEATURES

## Make Phone Calls

### Handset, Speaker and Headset Mode

The GRP260X allows users to switch among handset, speaker or headset when making calls. Press the Hook Switch to switch to handset; press the Headset button  to switch to headset mode; or press the Speaker button  to switch to speaker.

### Multiple SIP Accounts and Lines

The GRP2601 supports 2 SIP accounts and 2 line; GRP2602 supports up to 4 SIP accounts with 2 line keys; GRP2603/GRP2604 supports up to 6 SIP accounts with 3 line keys. Each account is capable of independent SIP server, user, and NAT settings. In off hook state, select an idle line and the dial tone will be heard. To make a call, select the line you wish to use. The corresponding LINE LED will light up in green. The user can switch lines before dialing any number by pressing the LINE buttons.

Since the GRP260x can have more SIP accounts than the supported lines, the phone is supporting two line key modes; “Line mode” and “Account mode”. The main difference between the two is that during calls each line key displays the status of a call line in “Line Mode”; while in “Account mode”, available accounts will be displayed in each line key, which is handy in case multiple accounts are using the same line. The figures below show the examples and difference of call screens between the two modes:

**Line mode:** Each line key is displaying the status of a call line



Figure 11 : Key mode configured as line mode

**Account mode:** An available account is displayed in each Line key. User can view the current line and the number of all lines in the upper right corner of the call interface.



Figure 12 : Key mode configured as account mode

Key mode setting can be configured from the phone's **Web GUI → Phone Settings → Call Settings**.

### Completing Calls

There are several ways to complete a call.

- **On hook dialing.** Enter the number when the phone is on hook and then send out.
  1. When the phone is in idle, enter the number to be dialed out;
  2. Take handset off hook, or Press Speaker button, or Press Headset button with headset plugged in.
  3. The call will be dialed out.
- **Off hook and dial.** Off hook the phone, enter the number, and send out.
  1. Take handset off hook; or
    - Press Speaker button; or
    - Press Headset button with headset plugged in; or
    - Press an available LINE key to activate speaker. (The user can return to idle screen after pressing again the activated Linekey).
  2. You shall hear dial tone after off hook;
  3. Enter the number;
  4. Press SEND or # keys to dial out.
- **Predictive dialing.** When dialing numbers, based on the entered digit, the phone will predict and list the candidates of target number.

If the target number is already saved in phonebook or call history, when entering the first several digits, the phone will display a list of matching numbers. If the target number appears on the list, user could select the

number using Up/Down key and dial out. GRP260x has predefined call feature code (the first digit is \*). When user enters \* as the first digit of the target number, the phone will list all the available feature codes.

- **Redial.** Redial the last dialed number.
  1. Take handset off hook; or
    - Press Speaker button; or
    - Press Headset button with headset plugged in; or
    - Press an available LINE key to activate speaker; or
    - When the phone is in idle state;
  2. Press SEND key, the last number called will be redialed.
- **Via Call History.** Dial the number logged in phone's call history.
  1. Press MENU button to bring up the main menu then enter Call History; or
  2. Press **"History"** soft key when the phone is in idle state;
  3. Select the entry you would like to call using the navigation arrow keys;
  4. Press SEND button to dial out.
- **Via Phonebook.** Dial the number from the phonebook.
  1. Press MENU button to bring up the main menu then enter Contacts; or
  2. Press **"Contacts"** soft key when the phone is in idle state;
  3. Enter Local / BS Phonebook using the navigation arrow keys;
  4. Select the contact you would like to call

**Note:** Pressing the **OK** button to enter the contact details page , users can edit the phone number and choose which account to dial that number by clicking **"Edit before dialing"** soft key.
  5. Press SEND button to dial the selected contact.

**Notes:**

- After entering the number, the phone waits for the No Key Entry Timeout (Default timeout is 4 seconds, configurable via Web GUI) before dialing out. Press SEND or # key to override the No Key Entry Timeout;
- If digits have been entered after taking the handset off hook, the SEND key will work as SEND instead



of showing the history of Dialed extensions;

- (#) or (\*) can be chosen as send keys from **WEB GUI** → **Accounts** → **Account X** → **Call Settings** → **Key as Send**.
- During an active call, users can see the call info on LCD:
  - The call lasting time
  - Contact information if the number is already saved in phonebook.

### **Making Calls Using IP Addresses**

Direct IP Call allows two phones to talk to each other in an ad-hoc fashion without a SIP proxy. VoIP calls can be made between two phones if:

- Both phones have public IP addresses; or
- Both phones are on the same LAN/VPN using private or public IP addresses; or
- Both phones can be connected through a router using public or private IP addresses (with necessary port forwarding or DMZ).

To make a direct IP call, please follow the steps below:

1. Press Hook Switch/Speaker or Headset button to bring out the dialing screen.
2. Input the 12-digit target IP address (Please see example below).
3. Press "**Dial**" softkey to dial.

#### **Notes:**

- When use direct IP call, "Use Random Port" option should be set to "No".

#### **For example:**

If the target IP address is 192.168.1.60 and the port is 5062 (i.e., 192.168.1.60:5062), input the following: 192\*168\*1\*60#5062. The \* key represents the dot (.), the # key represents colon (:).

When only dialing the IP address (example: 192\*168\*1\*60) the call will automatically go through the default port 5060.

### **Answering Phone Calls**

#### **Receiving Calls**

- Single incoming call.**

Phone rings with the selected ring tone. The corresponding LINE key will flash in red



(GRP2602/GRP2603/GRP2604) and the screen will indicate an incoming call. Answer call by taking handset off hook, or using Speaker/Headset, or pressing Answer softkey .



### ❑ Multiple incoming calls

When another call comes in while having an active call, the phone will produce a Call Waiting tone (stutter tone). The other LINE key will flash in red (GRP2602/GRP2603/2604). Answer the incoming call by pressing on the Answer softkey or the flashing LINE key in case of GRP2602/GRP2603/GRP2604. The current active call will be put on hold automatically. Users can switch between the calls using UP/DOWN keys.

### Do Not Disturb

Do Not Disturb can be enabled/disabled from phone's LCD by following the steps below:

1. Press the Menu button and navigate to "**Settings → Call Settings → Do Not Disturb**".
2. Use RIGHT/LEFT keys to disable/enable DND;
3. Press "**Save**" softkey to save the change

Users could also enabled/disable DND quickly by pressing the Mute button  or DND softkey .

DND Icon will be displayed on the top right of the status bar indicating that DND is enabled. Incoming calls will not be accepted, or the call will directly go into voicemail.

### Notes:

- The mute button function can be set also to idle Mute instead of DND or be disabled under the web GUI option **Phone Settings → Call Settings → Mute Key Function While Idle**.
- During an active call, press the MUTE button to mute/unmute the microphone. The LCD will show the Mute icon on the top of screen when the call is muted.

### Add Contact to Blacklist

If the contact number belongs to Blacklist group, the call from that number will always be blocked.

Users can add a contact to the blacklist by accessing local phonebook and selecting the contact in question and then pressing on the blacklist softkey , A confirmation message "Add this contact to Blacklist?" will be displayed on screen, the contact will be added to the blacklist by pressing on the "save" softkey.





To unblock a contact, users need to select the contact in question from the phonebook, and then press on unblock softkey .

## During a Phone Call

### Call Waiting/Call Hold

Users can place a call on hold by pressing the HOLD softkey  during an ongoing call. The active LINE key will blink in green (GRP2602/GRP2603/GRP2604). The call can be resumed by pressing on the Hold softkey again.

When there is a new call, the call screen will display the new incoming call information and Call waiting tone (stutter tone) will be audible during the active call, Use UP/DOWN keys to switch between the two calls screens.

Users can choose whether to answer the new call using Answer softkey , Reject the call using Reject softkey , forward the call using Transfer/Forward softkey  or mute /silence the call using silence softkey . When silence softkey is pressed, call waiting tone will be muted.

### Notes:

- If “**On Hold Reminder Tone**” is Enabled under web GUI “**Account X → Advanced settings**” then a reminder tone will be played to notify the user that he has a call on hold.
- If “**Enable call Waiting**” Option is set to **NO** on WEB GUI under **Account X → Call Settings** the second incoming call will be rejected.



### Mute

During an active call, press the MUTE button  to mute/unmute the microphone. The LCD will show the Mute icon on the top of screen when the call is muted.

### Call Transfer

GRP2601/GRP2602/GRP2603/GRP2604 supports Blind Transfer and Attended Transfer:





- **Blind Transfer.**

1. During active call, press TRANSFER button  .
2. Dial Transfer destination number.
3. Press Transfer softkey  to complete transfer of active call.







- **Attended Transfer.**

- During active call, press TRANSFER button  .
- Dial Transfer destination number and press on dial softkey  .
- The first call will be put on Hold and a new call will be initiated with the transfer destination.
- When the second call is answered, Users could press on Switch softkey  to switch to the initial call (The second call will be put on hold) or press on transfer softkey  to complete the transfer.

**Notes:**

- To transfer calls across SIP domains, SIP service providers must support transfer across SIP domains.
- When” **Hold Call before Completing Transfer**” Option is set to **"No"** on WEB GUI, the phone will neither hold the current call in transfer window nor hold the call with the transfer target before referring the call in the attended transfer.
- The Attended Transfer can be finished by on-hooking the phone.

**Call Forwarding**

When there is an incoming call, users could choose to not take call and forward it to another number instead by pressing on the Forward /Transfer softkey  and then dial the forward target number and press on  again, the call will be then immediately forwarded to that number.

**Establish Conferencing calls**

The GRP260x can host up to 5 conference calls.

**Initiate a conference call.**

1. Establish the first call.
2. While 1 call is active, press on conference Invite softkey  and dial the second conference number.
3. The conference will be established as soon as the dialed number answers the call.

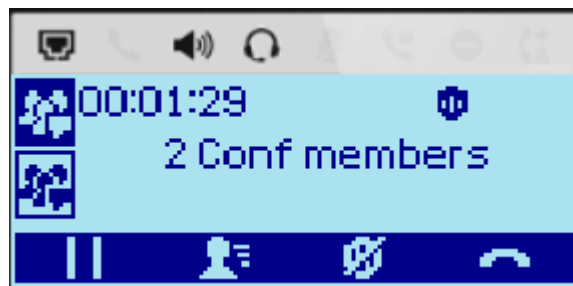





Figure 13 : 3-way conference call screen example

- **View Conference members.**

Users can view conference members by pressing on conference info softkey , Information related to conference members will then be displayed.

- **Kick Conference members.**

During conference, press on conference info softkey  to view conference members. Then use UP/DOWN softkey to select a member and press on kick softkey  to kick the selected number from conference.

- **End Conference.**

Users could press the End Call soft key  or simply hang up the call to terminate the conference call.

**Notes:**

- Viewing and kicking conference members is possible only if the phone is the conference host.
- The party that starts the conference call must remain in the conference for its entire duration, you can put the party on mute, but it must remain in the conversation.

### Multi-Purpose Keys (GRP2604 Only)

Users can configure Multi-Purpose keys (MPKs) from the phone's **WEB GUI -> Programmable Keys -> Multi-Purpose Keys**. The GRP2604 supports up to 10 MPKs. (Check figure below)

Order	Mode	Account	Value	Label
1	Speed Dial	Account 1	* 1000	John
2	Busy Lamp Field (BLF)	Account 1	* 2000	Jack
3	Voicemail	Account 1	* 5555	VoiceMail
4	None	Account 1		
5	None	Account 1		
6	None	Account 1		
7	None	Account 1		
8	None	Account 1		
9	None	Account 1		

**Preview**

After saving, you can print the card style in the preview

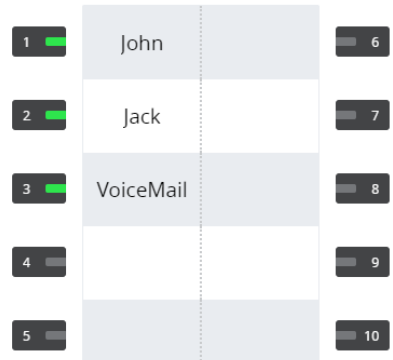

[Print](#)

Figure 14 : MPK page

In this section, The MPKs are listed by order (From 1 to 10). Users can configure an MPK by choosing the **Mode** they need to set (Speed dial, Busy Lamp Field...) and then set the **Value** for the MPK and the its **Label** (Description of the button). When done, scroll down and press on **Save** to save the configuration.

The Preview Section will show the label of each configured MPK in order:

Order	Mode	Account	Value	Label
1	Speed Dial	Account 1	* 1000	John
2	Busy Lamp Field (BLF)	Account 1	* 2000	Jack
3	Voicemail	Account 1	* 5555	VoiceMail
4	Speed Dial via Active...		* 1010	Carl
5	Transfer	Account 5	* 1001	Steve
6	Busy Lamp Field (BLF)	Account 1	* 1002	David
7	Speed Dial	Account 1	* 1002	Michael
8	Menu			Menu
9	Information			Infos
10	Forward	Account 1	* 1002	David

**Preview**  
After saving, you can print the card style in the preview



[Print](#)

**Figure 15 : MPK Preview**

**Note:** Multicast paging can be configured on the MPKs for GRP2604P phones.

Users can print the card containing the configured MPK information by pressing on **Print** and then configure the printing options and preferences such as the Print Destination, print all pages or specific ones, Layout, Paper size, Margins, Scale, whether to display headers and footers and background colors ...

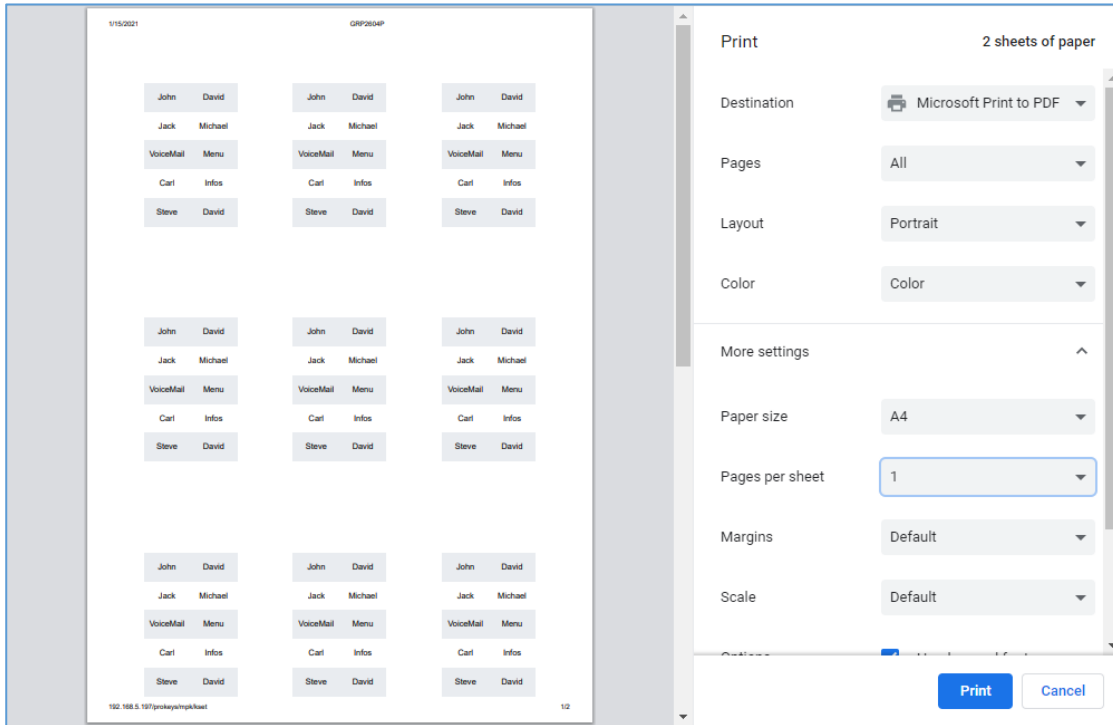

**Figure 16 : MPK Card printing options**

The MPK card can be printed over the dedicated space on the **BLF label** (Which can be found in the GRP2604 package content) and then follow the steps below to install it on the phone:

1. Place the paper label in the groove of the phone.
2. Bend the plastic film so that the protruding points on the left and right sides snap into the grooves to complete the installation.
3. If you want to take it out, use a nail or thin card to move the slit on one side of the film to bend it and then take it out.

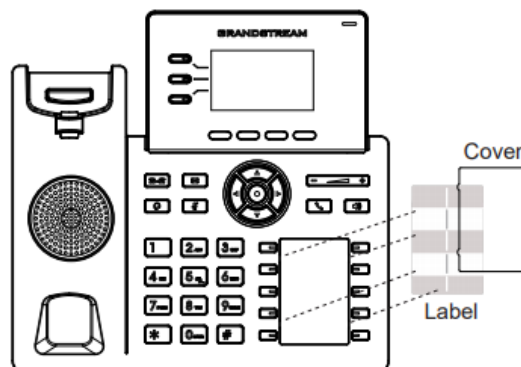

**Figure 17 : Install the BLF paper**

## Virtual Multi-Purpose Keys

Users can configure Virtual Multi-Purpose keys (VPKs) from the phone's **WEB GUI -> Programmable Keys -> Virtual Multi-Purpose Keys**. The GRP260X supports up to 12 VPKs. (Check figure below)

Order	Mode	Account	Value	Label	
1	Default	Account 1	899	Harv	
2	Busy Lamp Field (...)	Account 1	* 2002	Stev	
3	Multicast Paging	Account 1	* 237.11.10.11:6	Sup	
4	None				
5	None				
6	None				

**Figure 18: VPK Page**

In this section, The VPKs are listed by order (From 1 to 12). Users can configure a VPK by choosing the **Mode** they need to set (Speed dial, Busy Lamp Field...) and then set the **Value** for the VPK and the its **Label** (Description of the button). When done, scroll down and press on **Save** to save the configuration.

The Preview Section will show the label of each configured VPK in order:

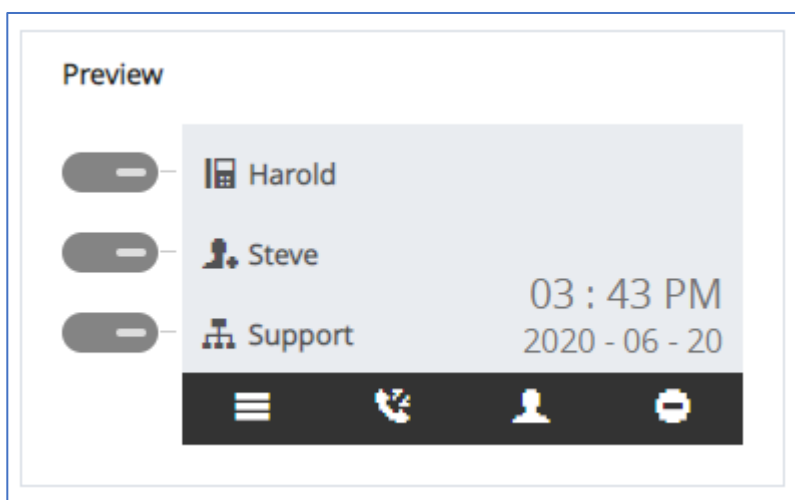

**Figure 19: VPK Preview**

## VoiceMail

The Message waiting indicator situated above the Message button will light up in green indicating a message is waiting. Go to Web GUI→Account →General Settings to configure Voicemail Access Number.

To retrieve the voicemail:

- Press Message hard key  to dial into the voicemail box.
- Select an account and check the number of Normal/Urgent voicemail displayed on screen. make operations according to the voice prompt.
- Press on dial softkey and follow the voice prompt to dial Voicemail access number and password which is configured on SIP server.
- Follow the voice prompt to read the awaiting messages or further operations.

The steps above are for the situation that two or three accounts are configured (GRP2602/GRP2603/GRP2604), if configured only one account, there is no need for users to select account but go to the dial-up interface directly.

For each account, the Voicemail User ID can be set up under Web GUI→Account X→General Settings: "Voice Mail Access number". This is the number that will be dialed out to access voicemail message when tapping on the account in Voice Mail screen.

## Call Features

The GRP260x supports traditional and advanced telephony features including caller ID, caller ID with caller Name, call forward etc.

**Table 15 : Call Features**

<b>*30</b>	<b>Block Caller ID</b> (for all subsequent calls) <ul style="list-style-type: none"> <li>• Off hook the phone;</li> <li>• Dial *30.</li> </ul>
<b>*31</b>	<b>Send Caller ID</b> (for all subsequent calls) <ul style="list-style-type: none"> <li>• Off hook the phone;</li> <li>• Dial *31.</li> </ul>
<b>*50</b>	<b>Disable Call Waiting</b> <ul style="list-style-type: none"> <li>• Off hook the phone;</li> <li>• Dial *50.</li> </ul>

<b>*51</b>	<b>Enable Call Waiting</b> <ul style="list-style-type: none"> <li>Off hook the phone;</li> <li>Dial *51.</li> </ul>
<b>*67</b>	<b>Call with Caller ID Blocked</b> (per call) <ul style="list-style-type: none"> <li>Off hook the phone;</li> <li>Dial *67 and then enter the number to dial out.</li> </ul>
<b>*82</b>	<b>Call with Caller ID Enabled</b> (per call) <ul style="list-style-type: none"> <li>Off hook the phone;</li> <li>Dial *82 and then enter the number to dial out.</li> </ul>
<b>*70</b>	<b>Call with Call Waiting Disable</b> (per call) <ul style="list-style-type: none"> <li>Off hook the phone;</li> <li>Dial *70 and then enter the number to dial out.</li> </ul>
<b>*71</b>	<b>Call with Call Waiting Enabled</b> (per call) <ul style="list-style-type: none"> <li>Off hook the phone;</li> <li>Dial *71 and then enter the number to dial out.</li> </ul>
<b>*72</b>	<b>Unconditional Call Forward.</b> To set up unconditional call forward: <ul style="list-style-type: none"> <li>Off hook the phone;</li> <li>Dial *72 and then enter the number to forward the call;</li> <li>Press OK softkey or SEND key.</li> </ul>
<b>*73</b>	<b>Cancel Unconditional Call Forward.</b> To cancel the unconditional call forward: <ul style="list-style-type: none"> <li>Off hook the phone;</li> <li>Dial *73;</li> <li>Hang up the call.</li> </ul>
<b>*90</b>	<b>Busy Call Forward.</b> To set up busy call forward: <ul style="list-style-type: none"> <li>Off hook the phone;</li> <li>Dial *90 and then enter the number to forward the call;</li> <li>Press OK softkey or SEND key.</li> </ul>
<b>*91</b>	<b>Cancel Busy Call Forward.</b> To cancel the busy call forward: <ul style="list-style-type: none"> <li>Off hook the phone;</li> <li>Dial *91;</li> <li>Hang up the call.</li> </ul>
<b>*92</b>	<b>Delayed Call Forward.</b> To set up delayed call forward: <ul style="list-style-type: none"> <li>Off hook the phone;</li> <li>Dial *92 and then enter the number to forward the call;</li> <li>Press OK softkey or SEND key.</li> </ul>
<b>*93</b>	<b>Cancel Delayed Call Forward.</b> To cancel the delayed call forward: <ul style="list-style-type: none"> <li>Off hook the phone;</li> <li>Dial *93 and then enter the number to forward the call;</li> <li>Press OK softkey or SEND key.</li> </ul>



- Off hook the phone;
- Dial \*93;
- Hang up the call.

**Note:** If the following feature codes do not work on your phone, please contact Administrator to turn on the “**Enable Local Call Features**” on phone’s Web GUI. **Enable Local Call Features** is under phone’s Web GUI→Account→Feature Codes tab.



# CONTACTS

## Local Contacts

The local contacts can save up to 2000 entries. Users can manage contacts by adding, deleting, and modifying single contacts, downloading contacts from HTTP/TFTP server, importing contacts from external storage, and exporting contacts to external storage.

For more details, please refer to the admin Guide:

[http://www.grandstream.com/sites/default/files/Resources/GRP260X\\_administration\\_guide.pdf](http://www.grandstream.com/sites/default/files/Resources/GRP260X_administration_guide.pdf)

## Add a single Contact

On the Local Contacts menu, select Local Phonebook then press on Add contact softkey  and input contact details such as First and last name, company/home/mobile numbers, distinctive Ringtone ... and then press "Save" soft key. The new contact will be added to your local phonebook.

## Phonebook

### XML Phonebook syntax

User can add contacts using the below syntax in phonebook.xml file:

```
<AddressBook>
<Contact>
  <id>3</id>
  <FirstName>SAUL</FirstName>
  <LastName>GOODMAN</LastName>
  <Frequent>0</Frequent>
  <Phone type="Work">
    <phonenumber>45426</phonenumber>
    <accountindex>0</accountindex>
  </Phone>
  <Phone type="Home">
    <phonenumber>54786</phonenumber>
```



```

    <accountindex>0</accountindex>

  </Phone>

  <Phone type="Cell">

    <phonenumber>08789654</phonenumber>

    <accountindex>0</accountindex>

  </Phone>

  <Primary>0</Primary>

  <Company>GRANDSTREAM</Company>

  <Department>SUPPORT</Department>

</Contact></AddressBook>

```





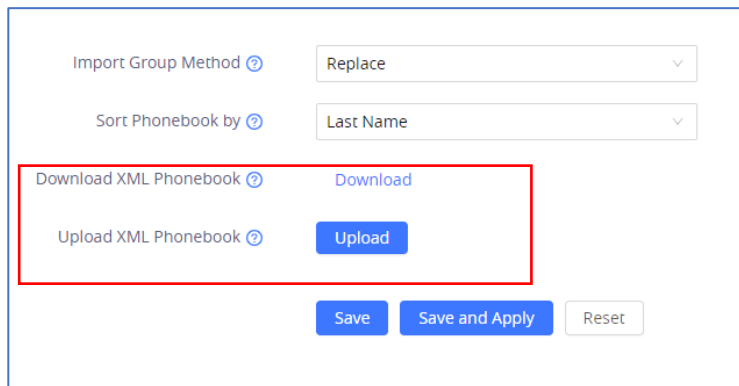

### Download/Upload XML Phonebook from Web UI

From the phone's web interface **under Application → Contact → Phonebook Management**, Use the button "Download" to retrieve the XML phonebook currently configured on the phone. Press the button "Upload" to choose your XML phonebook to upload to the phone.







**Figure 20: Download/Upload XML Phonebook**

User can also input the "Company", "Title", "Department" fields on the phonebook.xml like the previous example or through the phone's LCD by accessing a contact and pressing the "Edit" soft key  to edit the contact and add extra information before saving the contact.

**Note:** When accessing local phonebook, users could explore all available softkeys by pressing on "More" softkey , users could choose to look for a contact , Dial a contact number , Add New Contact , Block a contact number , delete a contact  or clear all contact list with  softkey.

### 3 XML PHONEBOOK URLS

Users can configure Up to 3XML Phonebooks URLs. This option can be found under device web GUI→ Application→ Remote phonebook.

	Display Name	URL	Username	Password
Phonebook 1	<input type="text"/>	<input type="text"/>	<input type="text"/>	<input type="password"/> 
Phonebook 2	<input type="text"/>	<input type="text"/>	<input type="text"/>	<input type="password"/> 
Phonebook 3	<input type="text"/>	<input type="text"/>	<input type="text"/>	<input type="password"/> 
Remote Phonebook Update Interval(m) 		<input type="text" value="0"/>		

**Figure 18: 3XML Phonebook**

# CALL HISTORY



## Local Call History

There are two categories in the local call history. Users could use LEFT/RIGHT navigation keys to switch between **All** calls Tab; **Missed** Calls Tab; **Dialed** Calls Tab; **Answered** Calls Tab and **Blocked** calls Tab. Below is the LCD icons indication for each type of calls:

Table 16: Call History icons

	<b>Dialed</b>
	<b>Missed</b>
	<b>Answered</b>
	<b>Rejected</b>

## Call History Operations

- **Dial number from call history:** Press on dial softkey  to or Send key to dial the number. The phone will use the same account as the call log when dialing out.
- **Delete a number from call history:** Select an entry then press “Delete” soft key  to delete the call log.
- **Clear call history:** Press on Clear All softkey  to clear the call history

**Note:** When users miss a call, the GRP260x will show a notification on the LCD idle screen indicating that a call was missed, user can check the call history then by pressing on History softkey or ignore the notification by pressing on  softkey.

## DIAGNOSIS

Users could access factory functions menu to diagnosis the phone's hardware/software. To do so please access to LCD menu under **Factory Functions**.

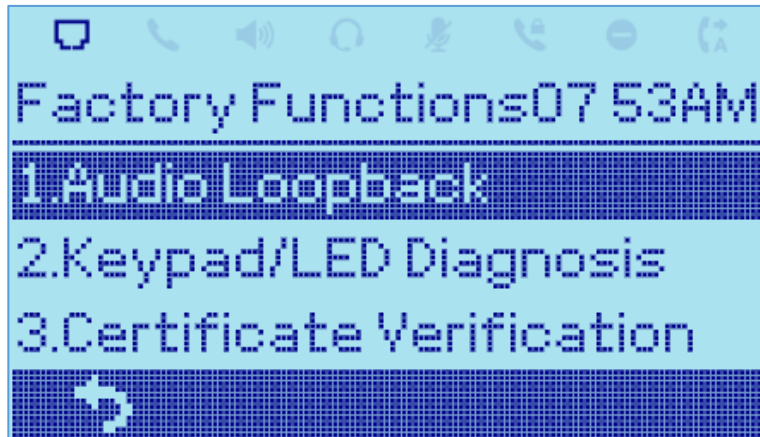



Figure 19: Factory Functions

These tools can be used to check the hardware and software status of the phone like verifying the LED, keypad buttons, Microphone/speaker functionality and certificates verification ...etc.

## EHS HEADSET

The GRP260x supports normal RJ9 headset jack (allowing EHS with Plantronics & Jabra & Sennheiser headsets).

Connect EHS Headset (Plantronics) to the GRP260x. To use headset mode, press headset button  on the phone. A headset icon  will show on status bar. The EHS headset will ring when there is an incoming call.

## RESTORE FACTORY DEFAULT SETTINGS

---

 **Warning:**

Restoring the Factory Default Settings will delete all configuration information on the phone. Please backup or print all the settings before you restore to the factory default settings. Grandstream is not responsible for restoring lost parameters and cannot connect your device to your VoIP service provider.

---

### Restore factory settings using LCD menu

Please follow the instructions below to reset the phone:

1. Press MENU button to bring up the keypad configuration menu.
2. Navigate to Settings → Advanced Settings.
3. Select "Factory Reset".
4. A warning window will pop out to make sure a reset is requested and confirmed.

Press the "Yes" Softkey to confirm and the phone will reboot, or "No" Softkey to cancel the Reset.

### Restore to Factory Default via Web GUI

1. Login GRP260X Web GUI.
2. Navigate to Maintenance → Upgrade and provisioning → Advanced Settings → Factory reset.
3. Press on **Start** Button situated against Factory reset option

Click "OK" to confirm and the phone will reboot, or on "Cancel" to cancel the Reset.



## EXPERIENCING GRP260x

Please visit our website: <http://www.grandstream.com> to receive the most up- to-date updates on firmware releases, additional features, FAQs, documentation, and news on new products.

We encourage you to browse our [product related documentation](#), [FAQs](#) and [User and Developer Forum](#) for answers to your general questions. If you have purchased our products through a Grandstream Certified Partner or Reseller, please contact them directly for immediate support.

Our technical support staff is trained and ready to answer all your questions. Contact a technical support member or [submit a trouble ticket online](#) to receive in-depth support.

Thank you again for purchasing Grandstream IP phone, it will be sure to bring convenience and color to both your business and personal life.

